

# The Edge™ Vent

## Installation Instructions

The Edge Vent is designed for asphalt shingled residential roofs with minimum 3/12 pitch. The Edge Vent should only be used at the edge of the roof for intake venting applications.

### IMPORTANT NOTES

1. It is recommended that edge flashing be used beneath The Edge Vent to conceal the roof deck-fascia board intersection.
2. See instructions below for cutting the slot.
3. When installing in cold weather, leave 1/8" gap between consecutive Edge Vent sections to allow for thermal expansion.
4. All nails used to pre-fasten The Edge Vent and to install shingles over The Edge Vent should be of sufficient length to penetrate the underside of the roof deck.
5. Avoid nailing starter and 1<sup>st</sup> course shingles directly above the roof deck slot.
6. Run The Edge Vent the full length of the eave.
7. Underlayment must be installed over top of The Edge Vent and flashed beneath the next layer to ensure that the water drains from the roof over the top of The Edge Vent.
8. In cold weather climates, install water proof shingle underlayment on roof deck beneath The Edge Vent to help protect the integrity of the deck. NOTE: Slot must be cut through underlayment for airflow.

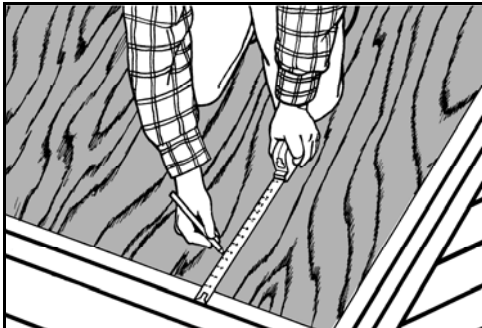

1. Remove all roofing materials for re-roof applications. Install edge flashing & gutter straps as necessary. Measure 5" from edge flashing bend to mark lower slot line. Measure 3/4" further up to mark upper slot line.

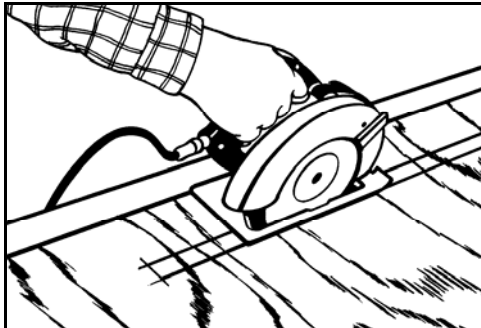

2. Cut slot with circular saw. **WARNING:** Adjust depth of blade to avoid cutting rafters or trusses. Refer to drawings below for slot dimensions. Remove debris from slot.

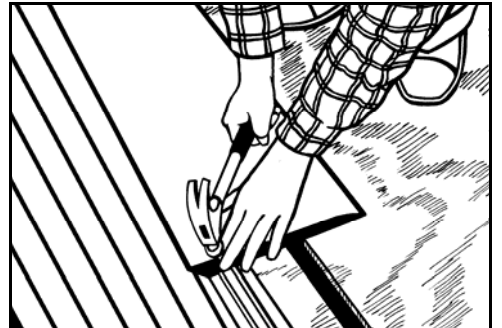

3. Position The Edge Vent over slot. Make sure that the lower edge of the venting slots is aligned with the edge flashing. Start at end of roof so that end plug is flush with end. Locating tabs on underside of The Edge Vent may assist in positioning over slot. Use reinforced nail holes to pre-fasten vent in place.



4. Use utility knife to cut final section to length. Integrated end plug of final section should be flush with end of roof. Pre-fasten final section.



5. Install underlayment over The Edge Vent being careful to avoid nailing above the slot. Using a chalk line, transfer the nail line (2 5/8" from drip edge) and slot location (5 3/4" to 7" from drip edge) to the top of the underlayment.

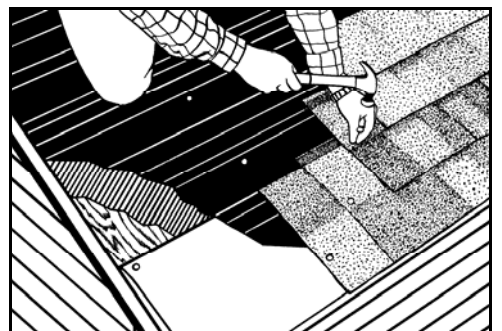

6. Install starter and first course shingles over underlayment-covered Edge Vent using shingle manufacturer guidelines. Nailing patterns may have to deviate from some shingle installation instructions to avoid nailing in slot location.

### INSTRUCTIONS FOR CUTTING SLOTS



Slot cut



Vent run



End wall

#### Hip & Gable Roofs

Cut 3/4" slot 5" up from drip edge. Terminate slot 6" inside of end walls and 12" from hip ridges. See Figure 7.

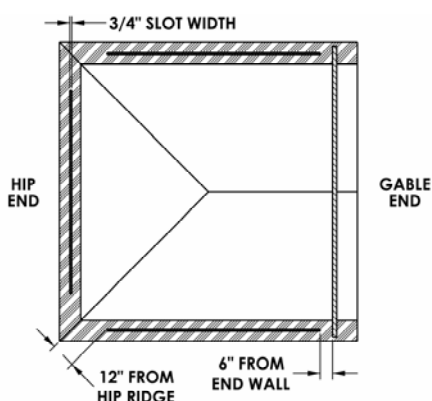

Figure 7 Hip & Gable Roofs

#### Roofs with Valleys

Cut 3/4" slot 5" up from drip edge. Terminate slot 6" inside of end walls and at least 12" from valleys. See Figure 8.

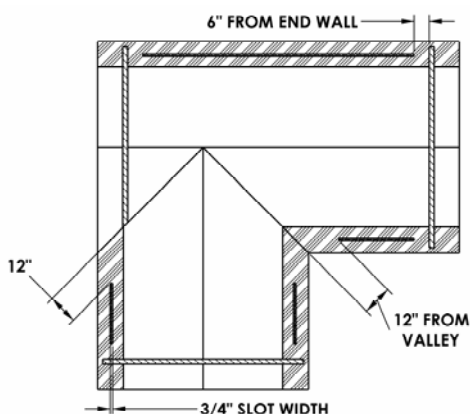

Figure 8 Roofs with Valleys

#### Chimneys

Cut 3/4" slot 5" up from drip edge. Terminate slot 12" from chimneys that penetrate the roof. See Figure 9.

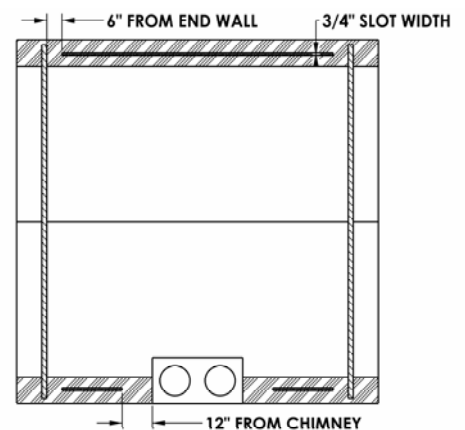

Figure 9 Chimneys

NOTE: Air Vent's written warranty for this product shall not apply in any instance in which the product was not installed in accordance with the instructions contained herein.

# The Edge™ Vent

## Installation Instructions

Use only on 3/12 roof pitches and steeper.  
Use only at the edge of the roof.

Thanks for choosing:



This product has been engineered to provide effective attic intake ventilation at the edge of the roof. When properly installed, The Edge Vent will:

- Help prevent the premature deterioration of shingles and other roofing materials caused by inadequate ventilation.
- Meet typical roof shingle warranty ventilation requirements.
- Help prevent attic heat build-up and ice dams by continuously moving air along underside of roof deck.

For best results, use with continuous exhaust vents.



The Edge intake vent can be coupled with continuous externally baffled ridge vents, such as Air Vent's ShingleVent II, for optimum performance. **NOTE:** Intake ventilation should match or exceed exhaust ventilation net free area.

### Tools needed for installation:

- Hammer
- Utility knife
- Chalk line
- Roofing nails
- Tape measure
- Circular saw

### The Edge Vent is easy to install!

Just follow these simple instructions. If there are questions or if special installation assistance is needed, call our toll-free number from 8 a.m. – 5 p.m. (C.S.T.) Mon. – Fri.: 1-800-AIR-VENT (247-8368)

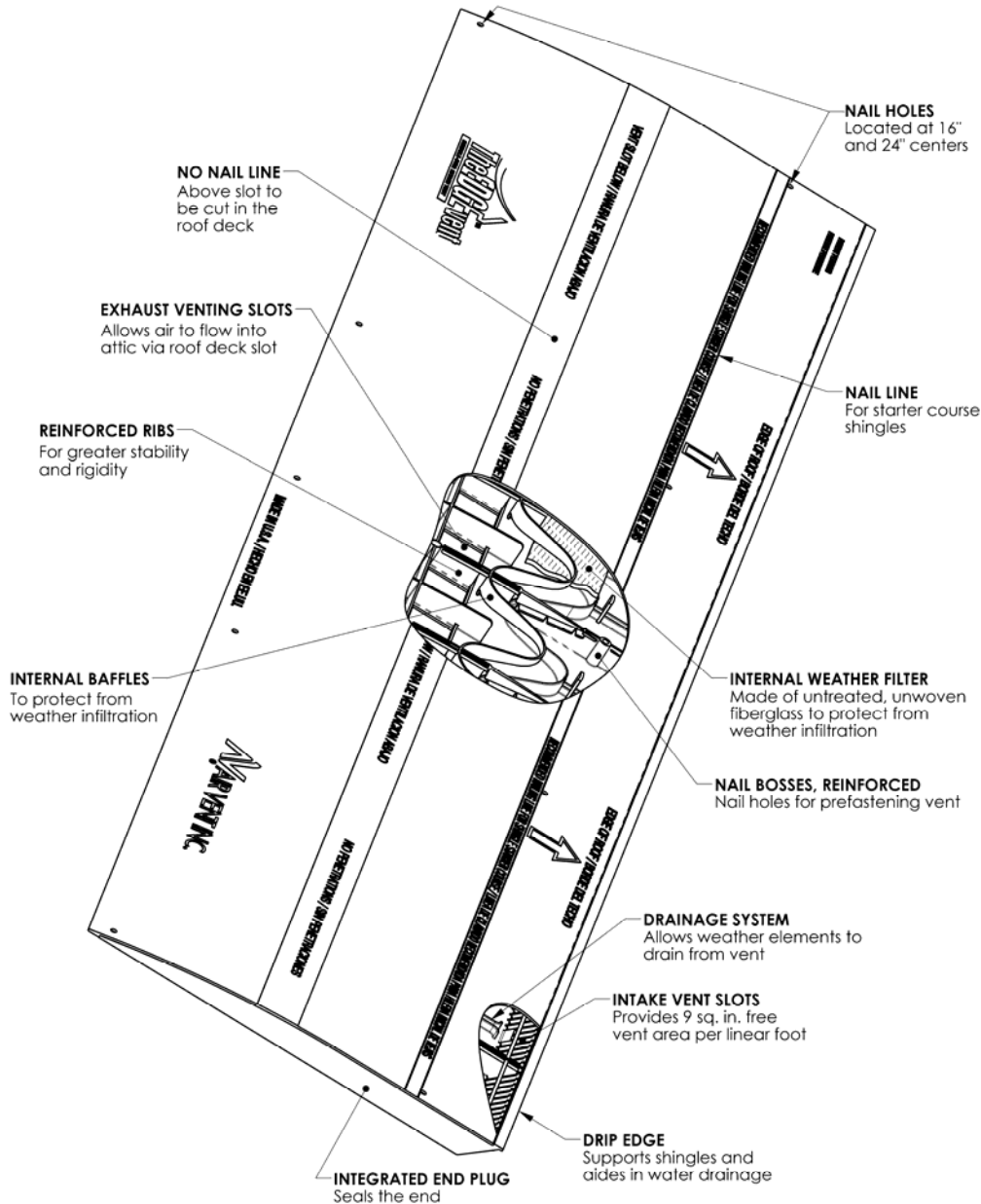

## Limited Lifetime Warranty

Limited, non-prorated and transferable

### What and Who is Covered and for How Long

Provided that the intake vent has been installed in strict accordance with Air Vent Inc.'s (Air Vent) written installation instructions, Air Vent warrants that its intake vent, The Edge Vent, will be free from manufacturing defects during the lifetime of the original purchaser.

Should any manufacturing defect occur during the lifetime of the original purchaser (and as long as the original purchaser is still living and retains ownership of the property), Air Vent will provide replacement material for that portion of the product deemed to be defective (not including labor costs incurred in removing defective vent or installing replacement product).

In the event of replacement according to the terms of this warranty, the original warranty shall apply to the replacement material and will extend for the balance of the original warranty period in effect at the time the vent proved defective.

The lifetime coverage by this warranty automatically ends upon the sale of the property or death of the last of the original owners of the property at the time of installation.

The lifetime coverage in this warranty is designed to cover individual homeowners only. In the case of intake vent purchased by, or installed upon property owned by corporations, governmental agencies, partnerships, trusts, religious organizations, schools, condominiums or cooperative housing arrangements, or installed on apartment buildings or any other type of building or premises not used by individual homeowners as their residences, the warranty period will be 50 years following the installation of the intake vent.

### Replacement Plus™ Protection

Air Vent intake ventilation product is covered by Replacement Plus™ protection for a period of 5 (five) years, provided that the intake vent has been installed in strict accordance with Air Vent's written installation instructions. Under this warranty feature, Air Vent, at no charge, will replace any intake vent found to be defective during the Replacement Plus™ period (the Replacement Plus™ period begins when the intake vent application is completed). Air Vent's maximum liability under Replacement Plus™ will be equal to the reasonable cost to replace the defective intake vent, including labor.

In instances in which Air Vent, according to the terms of this warranty, has agreed to pay the cost of labor required to replace a defective intake vent, Air Vent will provide reimbursement only upon receipt of a copy of the contractor's invoice or other written evidence of the completion of the work which Air Vent, at its sole discretion, deems acceptable.

### Transferability

If there is a change in ownership, the warranty may be transferred by the original purchaser of the intake vent to the new owner under the terms and conditions of this warranty. The warranty will then cover the period of 50 years following the purchase of the intake vent.

If the warranty is transferred from the original purchaser to a new owner during the 5 (five) year Replacement Plus™ period, the remaining period of Replacement Plus™ will be available to the subsequent property owner. At the end of the Replacement Plus™ period, the warranty will cover 50 years following the purchase of the intake vent.

### Limitations

Air Vent shall not be liable for, and this warranty does not apply to, any failure, defect or damage resulting from or connected with misuse, abuse, neglect or improper handling or storage, or installation not in strict adherence to Air Vent's written instructions; impact of foreign objects, fire, flood, earthquake, lightning, hurricane, hail, tornado or other violent storms or other act of God; or defects in, failure of or damage caused by materials used as a roofing base over which the vent is installed or by movement, distortion, cracking or settling of walls or the foundation of the building.

Air Vent reserves the right to discontinue or modify any of its products including color, and shall not be liable as a result of such discontinuance or modification, nor shall Air Vent be liable in the event replacement material may vary in color in comparison to the original product as a result of normal weathering. If Air Vent replaces any material under this warranty, it may substitute products designated by Air Vent to be of comparable quality or price range in the event the product initially installed has been discontinued or modified.

### Other Considerations

THIS WARRANTY IS EXPRESSLY IN LIEU OF ALL OTHER ORAL OR WRITTEN WARRANTIES, LIABILITIES OR OBLIGATIONS OF AIR VENT. PERTINENT STATE LAW SHALL CONTROL FOR WHAT PERIOD OF TIME SUBSEQUENT TO SALE A CONSUMER HOME OWNER MAY SEEK A REMEDY PURSUANT TO THE IMPLIED WARRANTY OF MERCHANTABILITY OR FITNESS FOR A PARTICULAR PURPOSE. IN NO EVENT SHALL AIR VENT BE LIABLE FOR CONSEQUENTIAL OR INCIDENTAL DAMAGES OF ANY KIND, INCLUDING ANY DAMAGE TO THE BUILDING, ITS CONTENTS OR ANY PERSONS THEREIN, RESULTING FROM THE BREACH OF ANY WARRANTY SET FORTH HEREIN. NO FIELD REPRESENTATIVE OF AIR VENT OR ANY DISTRIBUTOR OR DEALER IS AUTHORIZED TO MAKE ANY CHANGE OR MODIFICATION TO THIS WARRANTY. SOME STATES DO NOT ALLOW LIMITATIONS

ON OR THE EXCLUSION OF INCIDENTAL OR CONSEQUENTIAL DAMAGES, SO THE ABOVE EXCLUSIONS MAY NOT APPLY TO YOU.

**This warranty gives you specific legal rights, and you may also have other rights that vary from state to state.**

### What the Customer Must Do

To obtain performance under this warranty, the homeowner/consumer must notify Air Vent in writing of any manufacturing defect promptly following its discovery, and shall submit with such notification proof of date of purchase and vent installation, in order to provide Air Vent an opportunity to investigate the claim and examine the material claimed to be defective. All notifications shall be provided to: Air Vent Inc. 7700 Harker Drive, Peoria, Illinois 61615. Air vent shall then promptly inspect the claimed defect before the furnishing of any replacement vent is approved, and Air Vent shall, within a reasonable time after approval, provide a replacement vent (or vents) under the terms of the warranty. This warranty is effective on the intake vent applied on or after March 1, 2008.

PLEASE COMPLETE THIS FORM AND RETAIN WITH YOUR IMPORTANT PAPERS

Date installed \_\_\_\_\_

Installed by \_\_\_\_\_

Address \_\_\_\_\_

City \_\_\_\_\_

State \_\_\_\_\_ Zip \_\_\_\_\_

Property owner \_\_\_\_\_

Property address \_\_\_\_\_

City \_\_\_\_\_

State \_\_\_\_\_ Zip \_\_\_\_\_



4117 Pinnacle Point Drive  
Suite 400  
Dallas, Texas 75211

PN 717311